

electricQ

User manual

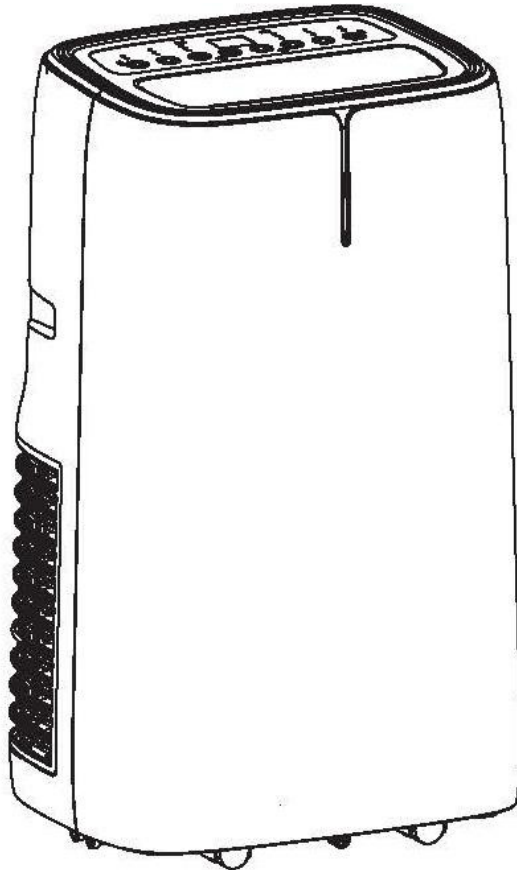

PORTABLE AIR CONDITIONER WITH WiFi SMART APP

EcoSilent10W-V2 & EcoSilent12W & EcoSilent14W

Thank you for choosing electricQ.

Please read this user manual before using this innovative Air Conditioner and keep it safe for future reference.

Visit our page, www.electricQ.co.uk, for our entire range of Intelligent Electricals.

Welcome to electriQ

We hope you're happy with your new purchase.

We'd love to see how you're getting on.

If you share any snaps on your socials,
make sure you tag us and use our hashtag.



@electriQUK
#electriQUK

We're here to help

Got a question or need help?

Get in touch with our friendly customer service team.



0330 390 3061

support@electriQ.co.uk

Mon - Fri | 9am to 5pm

**Unit 2A, Trident Business Park, Neptune Way,
Leeds Road, Huddersfield, HD2 1UA**

CONTENTS

SAFETY INSTRUCTIONS	4
FEATURES	7
PARTS	7
INSTALLATION	8
OPERATION	10
REMOTE CONTROL	13
WIFI SMART CONTROL	15
CLEANING AND MAINTENANCE	24
EMPTYING THE INTERNAL WATER TANK	25
TROUBLESHOOTING	26
ERROR CODES	27
TECHNICAL SPECIFICATION	27
SUPPORT	29

SAFETY INSTRUCTIONS

Important!

- Carefully read the instructions before operating the unit.
- This appliance is for indoor use only.
- Rating: This unit must only be connected to a 220-240 V / 50 Hz earthed outlet. The fuse rating can be found on the plug itself.
- Installation must be in accordance with the applicable regulations of the country where the unit is used.
- If you have any doubt about the suitability of your electrical supply, have it checked and, if necessary, modified by a qualified electrician.
- This appliance is not intended for use by persons (including children) with reduced physical, sensory or mental capabilities. It is also not intended for use by those with a lack of experience and knowledge unless they have been given supervision or instruction concerning the use of the appliance by a person responsible for their safety.
- Do not leave children unsupervised with this appliance.
- You must follow the venting and set-up instructions; Incorrect operation can result in damage to the unit, which is not covered under your warranty.
- This air conditioner has been tested and is safe to use. However, as with any electrical appliance, use it with care.
- Do not obstruct any of the ventilation openings.
- The airflow should never be restricted, for example, by venting the unit into a condenser box or reducing the hose diameter, as this can damage the unit.
- Disconnect the power from the appliance before dismantling, assembling or cleaning.
- An authorised service representative should perform any service other than regular cleaning or filter replacement. Failure to comply could result in a voided warranty.
- Avoid touching any moving parts of the appliance.
- Never insert fingers, pencils or any other objects through the guard.
- **WARNING:** Do not pierce or burn any part of the unit.
- Do not clean the unit by spraying it or immersing it in water.
- Never connect the unit to an electrical outlet using an extension cord. If an outlet is not available, one should be installed by a qualified electrician.
- Never operate this appliance if the cord or plug is damaged. Ensure the power cord is not stretched or exposed to sharp objects/edges.
- A damaged supply cord should be replaced by the manufacturer or a qualified electrician to avoid a hazard.
- Do not use the appliance for any purpose other than its intended use.
- **The air conditioner unit must always be stored and transported upright; otherwise, irreparable damage may be caused to the compressor. If there is doubt, we suggest waiting at least 24 hours before starting the unit.**
- Avoid restarting the air conditioning unit unless 3 minutes have passed since being turned off. This prevents damage to the compressor.
- Never use the mains plug as a switch to start and turn off the air conditioning unit. Use the provided POWER button located on the control panel.







- Always place the unit on a dry, stable, flat surface.
- The appliance should not be installed in the laundry or wet rooms.
- The appliance must be placed in a room without sources of ignition (for example, open flames, an operating gas appliance or an operating electric heater).
- R290 refrigerant gas complies with European environmental directives.
- R290 has a low GWP (Global Warming Potential) of 3.
- The air conditioners contain the following quantity of refrigerant gas:

EcoSilent10W-V2	210g
EcoSilent12W	260g
EcoSilent14W	300g

- Do not install or store in an unventilated space with an area smaller than shown in the table below per system. Smaller room sizes may be suitable if other safety measures are implemented and a risk assessment is conducted

EcoSilent10W-V2	10.1 m ²
EcoSilent12W	12.5 m ²
EcoSilent14W	14.4 m ²

- The room must be designed to prevent the stagnation of possible refrigerant leaks, as there could be a fire or explosion hazard if the refrigerant comes into contact with electric heaters, stoves, or other sources of ignition.
- **WARNING:** The appliance must be stored in a room without continuously operating ignition sources, for example, open flames, an operating gas appliance or electric heaters.
- Only store and use the unit whilst upright; do not lay it down or tip it.
- Do not place the unit near any ovens or other heat sources. This may be dangerous, but it will lead to the unit working harder and using more energy.
- Do not place the unit in direct sunlight; this can affect its appearance and cause it to work harder and be less energy efficient.
- Refrigerant gas may be odourless.
- Do not use the product and contact the retailer for advice if damage has occurred to the unit, which may have compromised the refrigerant system.
- Any repairs or maintenance must only be conducted by a suitably qualified engineer. Before opening and servicing the unit, the authorised engineer must possess a copy of the manufacturer’s service manual and follow the safety information it contains to minimise all hazards.
- The refrigerant system should not be perforated or punctured.
- At the end of the unit’s lifetime, always dispose in line with local regulations.
- Ensure all storage conditions in the manual are followed.
- **WARNING:** Do not use means to accelerate the defrosting process or to clean the unit.

	<p>WARNING: This appliance contains flammable refrigerant. If this leaks and comes into contact with an external ignition source, there is a fire risk.</p>
	<p>CAUTION: The operation manual should be read thoroughly.</p>
	<p>CAUTION: Any service personnel working on the unit should read the service manual prior.</p>
	<p>CAUTION: Information on operation and servicing is in the manual.</p>

ENERGY SAVING AND UNIT SAFETY PROTECTION TIPS

- Do not cover or restrict the airflow from the outlet or inlet grilles.
- For maximum performance, the minimum distance from a wall or object should be 50cm.
- Keep the filters clean. Under normal conditions, filters should only need cleaning once every three weeks (approximately). Since the filters remove airborne particles, more frequent cleaning may be necessary, depending on the air quality.
- For the initial start-up, set the fan speed to maximum and the thermostat to 5 degrees lower than the current temperature. Afterwards, set the fan switch to low and set the thermostat to your desired setting.
- To protect the unit, we recommend not using the cooling function when the ambient temperature exceeds 35 °C. The unit's performance may be affected at lower temperatures than this. If a scorching day is predicted, running the unit overnight in the desired room is recommended.

FEATURES

- 3 in 1 cooling, fan, and dehumidifier.
- 5-speed DC fan: Balancing quiet operation with performance.
- Smart Cool logic for improved energy efficiency.
- HEPA Filter for Air Purification.
- 24 Hours Start/Stop Timer
- Digital Thermostat: Set the temperature between 16°C and 32°C.
- WiFi app control.
- Remote Control.
- Castors and Handle for Enhanced Portability.

PART LIST

NOTE: Images in the manual are for illustrative purposes only; due to ongoing product improvements, the product may differ from the illustrations.

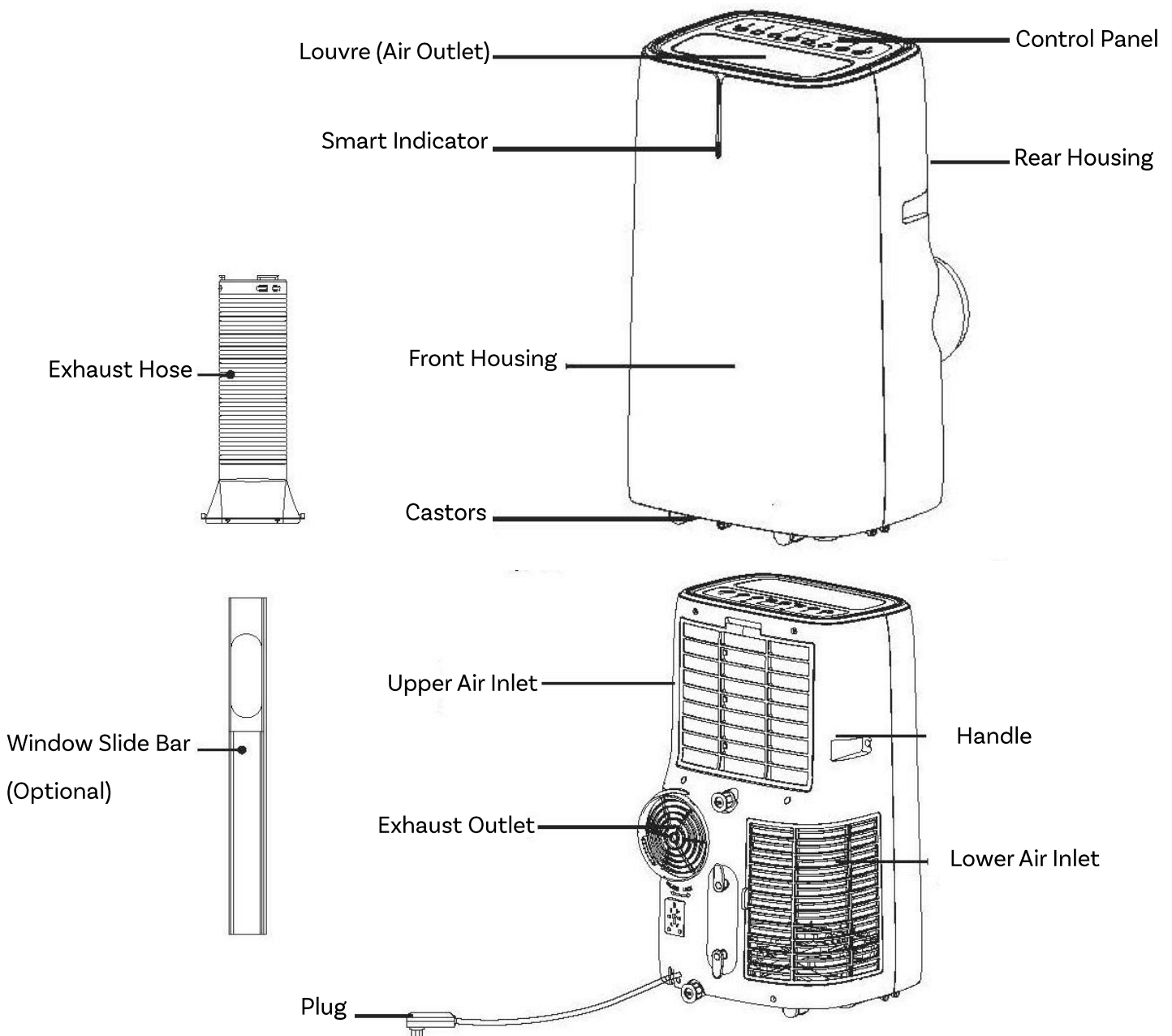

INSTALLATION

WARNING: Before using this unit, please keep it upright for at least 3-4 hours.

This unit can easily be moved from one room to another. While moving the unit, please keep it upright and place it on an even surface.

IMPORTANT: The exhaust hose only needs to be fitted in cooling mode and smart cool.



1. Attach the fishtail connector to the end of the hose by extending the end and twisting until firmly attached to the connector (At least 3 full rotations).

2. Attach the Hose to the Exhaust adaptor in the same way by extending the end of the hose and twisting until firmly attached (At least 3 full rotations).

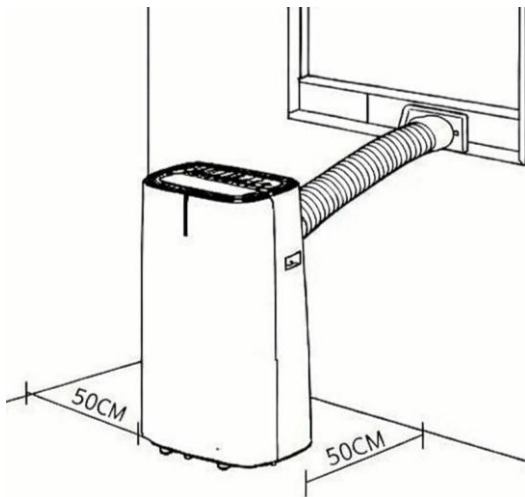
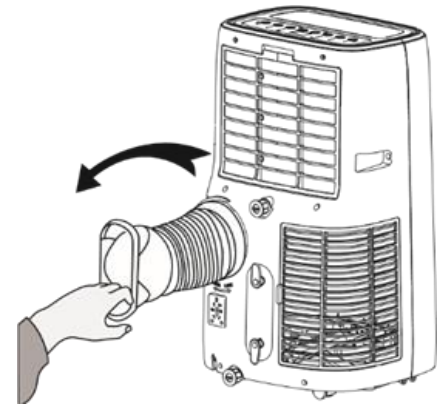

3. Make sure the unit is upright, and there are no obstructions to the air inlets and outlet grilles, with at least 50cm of space to the sides and rear of the unit.

IMPORTANT SAFEGUARDS

The length of the soft hose extends from approximately 35 cm to 200 cm. If the hose is extended above this length, the unit may malfunction, which can invalidate the warranty. The outlet vent must be well-ventilated and unobstructed, or the unit will overheat. Keep the hose as straight and short as possible and avoid bending the air hose by more than 30 degrees to maintain the unit's performance. Excessive bends in the hose may prevent the unit from expelling hot air, leading to internal damage and invalidating the warranty.

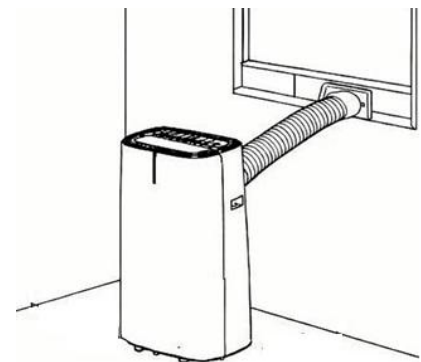
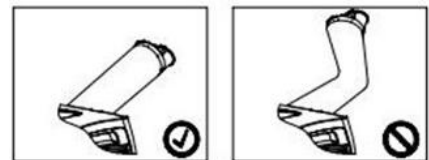

INSTALLATION OF WINDOW KIT (OPTIONAL)

The window kit (slide bar and fishtail adaptor) is suitable for use with sliding windows and doors. For other window types, use the fishtail adaptor alone and reduce cooling loss by closing curtains or using a window seal or blockers such as AC-AIRLOCK.

1. Slide the rear section of the slide bar onto the front section, lining up the plate so it runs within the groove. Extend the bar to the required length and use the supplied wing nut to secure it.

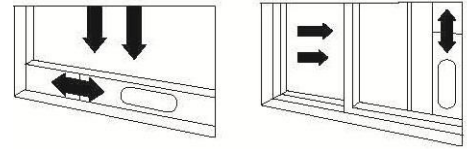

2. Push the screw thread of the plate through the hole in the rear of the front slide bar section.



3. Partially open the window and place the extended slide bar in position before closing the window onto it.
4. Fix the fishtail adaptor into the opening on the slide bar.

NOTES:

- The window kit is only designed to be installed with sliding or sash windows or doors. The window kit is not designed to be used with any other style of windows.
- The fishtail adaptor can be used without the slide bar with most windows/doors.
- When using the air conditioner, ensure that the opening around the fishtail adaptor is as small as possible to ensure the unit's efficiency is not reduced.
- The best form of installation is through a wall duct. By adequately venting, you expel hot air from your room while efficiently cooling it.
- Your air conditioner should be used without the vent hose in dry mode. When using dry mode, ensure an external water tank is used, monitored, and regularly emptied to prevent overflow.

OPERATION

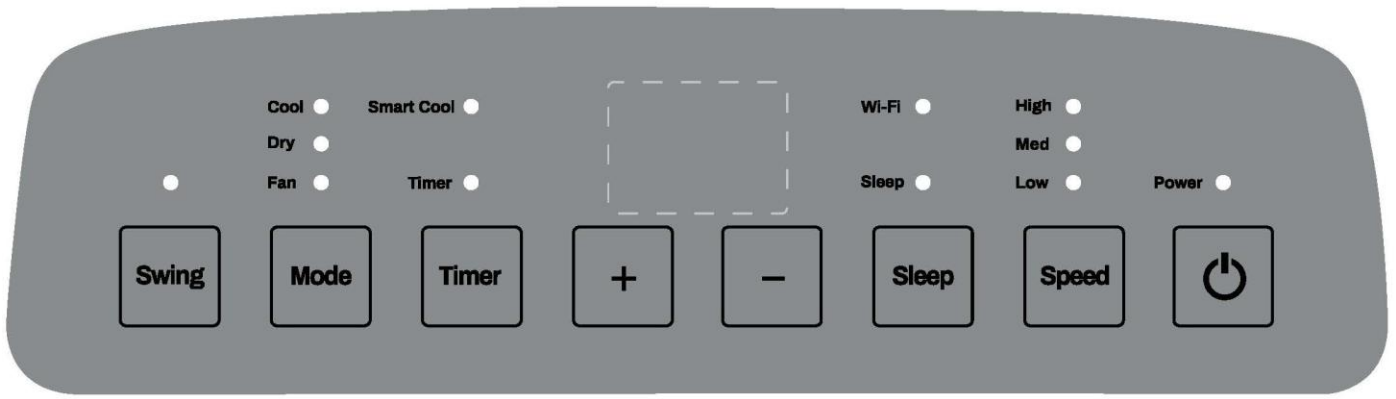

Press the POWER button to turn the unit ON or OFF.



Press the MODE button to cycle through the 4 modes; the indicator for the selected mode will illuminate.

COOL: The room is cooled by cold air expelled through the front air outlet, while hot air is expelled through the vent hose. The desired room temperature can be set between 16 and 32 degrees using the + and - buttons, and the fan speed can be changed using the SPEED button. The compressor will turn off when the unit detects that the room is 1 degree below the target temperature and will restart the compressor when it is 1 degree above. The smart indicator will light up blue in this mode.

FAN (AIR PURIFIER): Fan speed can be adjusted by pressing the SPEED button. When used with the optional HEPA filter, the appliance will work as an effective air purifier. The indicator will light up green in this mode.

DRY (DEHUMIDIFY): Should be operated without the vent hose, but with continuous drainage to remove moisture from the air. The display will show dH while in dry mode. The fan speed is set to low and is not adjustable. We advise continuous drainage to be set up in DRY mode. The indicator will light up orange in this mode.

SMART COOL: An automatic cooling mode that adjusts the fan speed according to the cooling demand. As the room approaches the target temperature, the unit operates more quietly. Manually changing the fan speed will switch the unit to COOL mode. In SMART COOL, the smart indicator illuminates blue and the control panel indicator turns on.



Used to adjust the temperature in COOL/SMART COOL modes and to set the duration of the TIMER.

Press the SPEED button to change between the five fan speeds. The display and LEDs will indicate the currently selected fan speed. The fan speed cannot be altered in SMART COOL and DRY modes.

Speed

Fan Speed	Display	LEDs Illuminated
Quiet	F1	Low
Low	F2	Low & Medium
Medium	F3	Medium
High	F4	Medium & High
Turbo	F5	High

Press and hold the SPEED button on the unit for 3 seconds to lock the controls and "CL" will show on the display. Press and hold the same button for 3 seconds to unlock the panel.

Switching the unit off at the mains clears the child lock.

Sleep

Press to enter sleep mode. The sleep indicator will be illuminated, and all other indicators will be turned off. In sleep mode, the appliance works at low fan speed. Press SLEEP again to exit sleep mode.

WIFI: With the unit operating, hold the sleep button for 3 seconds to turn the WiFi connection mode on. Hold the button for 3 seconds again to turn WiFi off.

Timer

The timer functions cannot be combined or repeated.

POWER ON TIMER

With the appliance in standby, press the TIMER button to set the power-on timer. Use the + and - buttons to adjust the timer's duration (1 to 24 hours). The Timer indicator will turn on, and the unit will start after the selected number of hours.

POWER OFF TIMER

With the appliance running and set to the desired settings, press the TIMER button to set the power-off timer. Use the + and - buttons to adjust the timer's duration (1 to 24 hours). The timer indicator will illuminate, and the unit will stop after a selected number of hours.

Swing

Press this button to enable the Swing function. The louvres will slowly move back and forth. If the Swing is pressed again, the louvres will stop in their current position.

Hold the Swing button for 3 seconds, and the unit will operate with the existing settings, with the lights off.

SMART INDICATOR

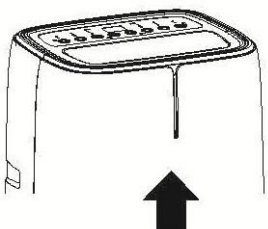

Smart Indicator

The unit's smart indicator will light up different colours depending on the mode being run. This is designed so the mode can be easily spotted from a fair distance.

COOL	Blue
SMART	Blue
FAN	Green
DRY	Orange

SMART COOL

When you turn on the smart cool function, the unit will select the appropriate fan speed based on the difference between your desired temperature and the current temperature. If the difference is more than 2 degrees, the unit will use the maximum fan speed; if it is less than 2 degrees, it will use level F3.

Every 20 minutes, the unit will read the room temperature and adjust the fan accordingly. If the fan is already set to the maximum or minimum speed, the speed will not be adjusted further.

Scenario	Adjustment	Example
Desired temperature reached	Fan speed decreases by one level.	The desired temperature is 22; the Current room temperature is 22.
The current temperature has risen in the last 20 minutes.	Fan speed increases by one level unless it is already at the maximum.	The desired temperature is 22; the room temperature 20 minutes ago was 23 and is now 24. The fan speed increased from F2 to F3.
The current temperature hasn't dropped more than a quarter of the difference between the current temperature and the desired temperature 20 minutes ago.	Fan speed increases by one level unless it is at max.	The desired temperature is 22; the room temperature 20 minutes ago was 28 and is now 27. The fan speed increased from F2 to F3.
The current temperature has dropped more than half of the difference between the current temperature and the desired temperature 20 minutes ago.	Fan speed decreases by one unless it is already at the minimum.	The desired temperature is 22; the room temperature 20 minutes ago was 26 and is now 22. The fan speed decreased from F3 to F2.
Any temperature change that is not described.	Continues at the same speed	The temperature stayed the same.

REMOTE CONTROL



	Press to turn the unit on or off.
	Press to increase or decrease the desired temperature or timer duration.
MODE	Repeatedly press to select your desired mode.
SPEED	Repeatedly press to select your desired fan speed.
TIMER	Press to set the timer.
CHILD LOCK	Press and hold the CHILD LOCK button for 3 seconds to lock the control panel; “CL” will appear on the LED display. Press and hold the same button for 3 seconds to unlock it. Turning the unit off at the mains will clear the child lock, but all other settings will be retained when the unit is switched back on.
SLEEP	Press to enter sleep, press again to exit sleep.
SWING	Press to activate swing mode. Press again, and the louvres will stop in the position they are in.
AUTO	Press to enter Smart Cool mode.
TURBO	To turn the fan to the highest fan speed and the lowest temperature.
COOL	Press to enter cool mode.

REPLACING THE BATTERIES

Remove the battery cover, insert two 1.5V AAA batteries following the correct polarity, then reattach the battery cover securely. Do not use the remote if the battery cover does not securely attach.



WARNING: Do not mix batteries of different voltages, chemistries, brands, or charge levels. Combining mismatched batteries can cause overheating, leakage, rupture, or device malfunction. Always replace all batteries at the same time using identical type and voltage ratings.

MULTI PROTECTIVE FUNCTIONS

FROST PROTECTION

In COOL, DRY, or SMART COOL modes, if the exhaust temperature is too low, the machine will automatically stop until the temperature rises.

OVERFLOW PROTECTION

When the water in the internal water tank exceeds the warning level, the machine will stop operating and sound an alarm with the LCD showing "FL". To resume operation, empty the internal water tank. After emptying the water, the machine will automatically return to its original state.

AUTO-DEFROST

The machine has an automatic defrosting function. If the internal coils' temperature drops too low during operation, the unit will enter auto defrost.

AUTOMATIC THERMAL PROTECTION

To protect the machine's service life, it features automatic thermal protection. If the temperature within the unit is outside of the specified range, the compressor and the lower motor will stop operation. After the machine's temperature returns to normal, the appliance will automatically resume regular operation.

COMPRESSOR PROTECTION

There is a 3-minute delay in starting the protection function to prevent damage to the compressor.

INSTALLING THE HEPA FILTER (Optional)

You can install a HEPA filter in this unit, which will purify the air expelled back into the room in any operating mode. These can be purchased from the retailer using stock code **FIL-ECOSILENTHEPA**.

Unwrap the HEPA filter, then remove the upper filter frame from the unit by pressing the two clips at the top of the frame. Place the filter into the filter frame, then clip the frame back into place.

HEPA filter replacement intervals vary depending on air quality, runtime and fan speed. Vacuum the filter every two weeks to extend its lifespan, and replace it after a minimum of six months of continuous use.

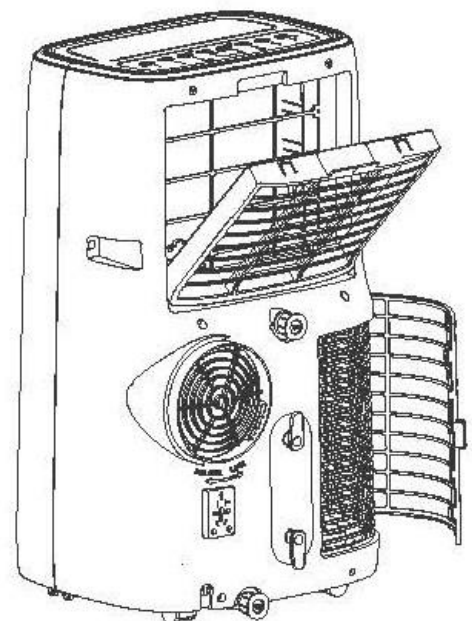

WiFi SMART CONTROL

BEFORE YOU START

- Ensure your router provides a standard 2.4Ghz connection.
- If your router is dual-band, ensure that both networks have different network names (SSID). Your router / Internet service provider can provide advice specific to your router.
- Place the air conditioner as close as possible to the router during setup.
- Once the app has been installed on your phone, turn off the data connection, and ensure your phone is connected to your router via WiFi.

DOWNLOAD THE APP TO YOUR PHONE

Download the "TUYA SMART" app from your chosen app store, using the QR codes below, or by searching for the app in your chosen store.



Android



IOS

CONNECTION METHODS AVAILABLE FOR SETUP

Before starting the setup, ensure the air conditioner is switched on and operating. Press and hold the SLEEP button for 3 seconds (until you hear a beep) to enter WiFi connection mode. The WiFi light on the air conditioner will flash to indicate it is ready to connect.

When connecting the Air Conditioner to your WiFi network there are two ways your network details can be uploaded to the appliance. If you have turned on Bluetooth on your phone, the app will detect the Air Conditioner and guide you through the simple setup process. Alternatively, the AP connection method uses a direct local WiFi connection between your phone and the air conditioner, allowing the app to upload the network details. This is ideal when you do not have a Bluetooth enabled device or encounter problems following the Bluetooth setup.

REGISTER THE APP

1. Press on the Sign Up button at the bottom of the screen.

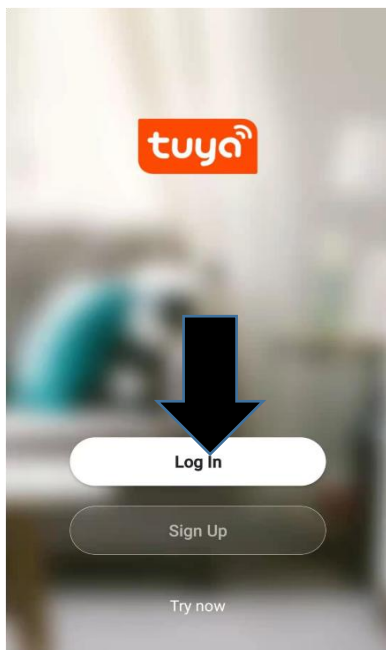

2. Read the Privacy policy and press the Agree Button.

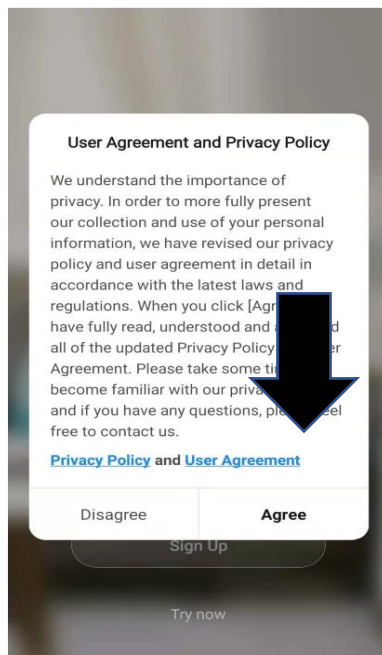

3. Enter your email address or phone number and press continue to register.

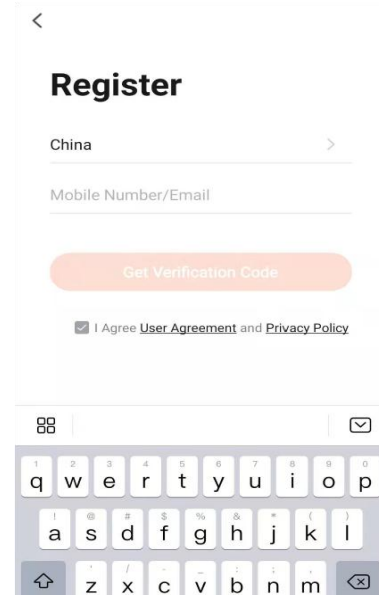

4. A verification code will be sent by the method selected in step 3. Enter the code into the app.

←

Verification Code

Verification code has been sent to:
Resend(57s)

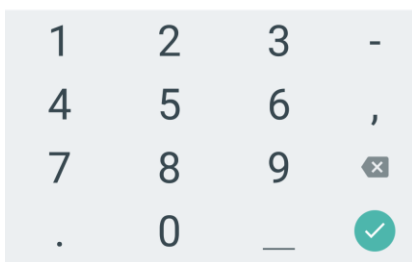

5. Type in the password you would like to create. This needs to be 6-20 characters, with letters and numbers.

←

Set Password

Password must contain 6-20 letters and numbers

Done

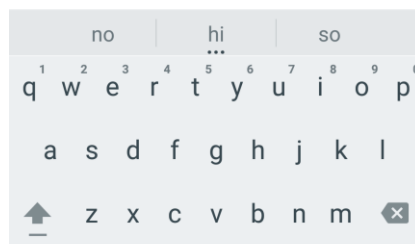

6. The app is now registered. It will automatically log you in following registration.

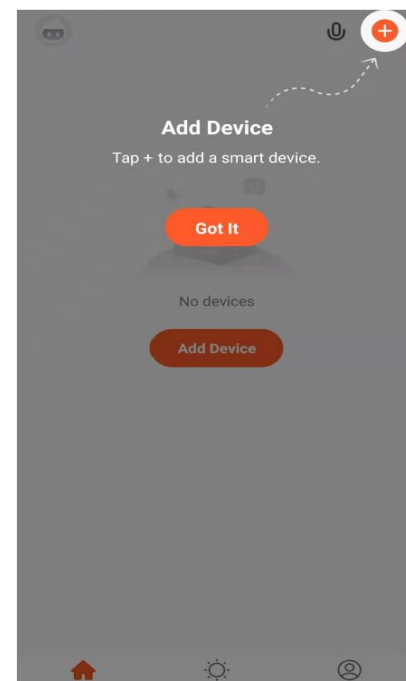

SETTING UP YOUR HOME WITHIN THE APP

TUYA is designed to work with a large number of compatible smart devices within your home and multiple devices within different houses. As such, during setup, the app requires that different areas be created and named to make it easier to manage all your devices. When devices are added, they are assigned to one of the rooms you have created.

CREATING ROOMS

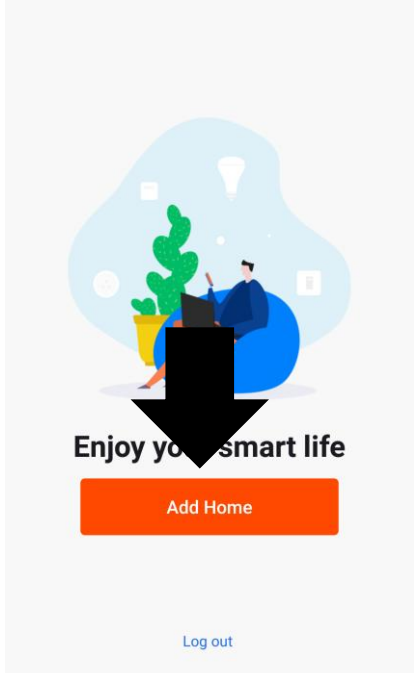
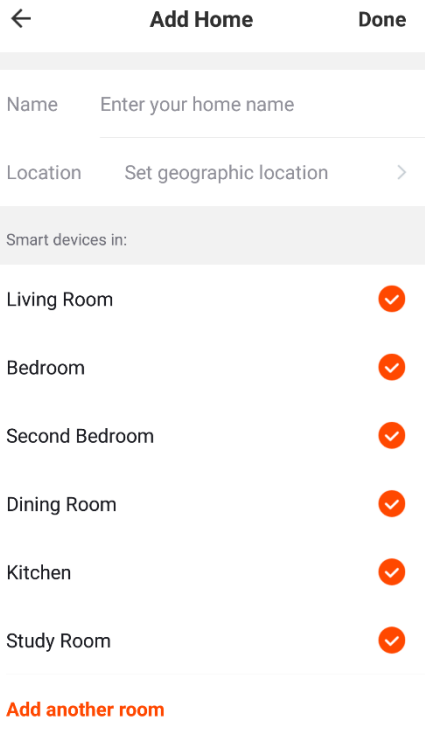
<p>1. Press on the ADD HOME button.</p> 	<p>2. Type in a name for your home</p> <p>3. Press on the location button to select the location of your home. (See SETTING YOUR LOCATION below)</p> <p>4. New rooms can be added by pressing the ADD ANOTHER ROOM option at the bottom. (See ADD ANOTHER ROOM below)</p> <p>5. Untick any rooms that are not required on the app.</p> <p>6. Press DONE in the top right corner.</p>	
--	--	--

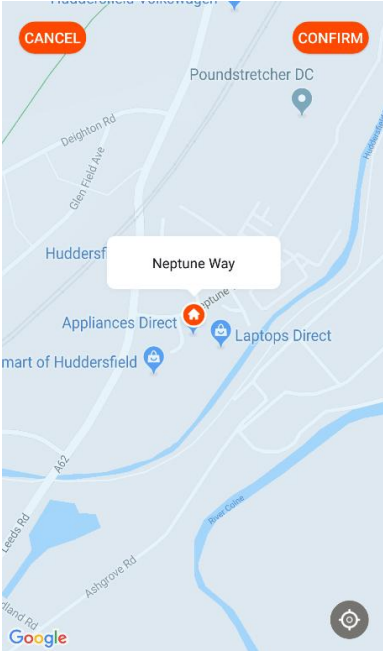
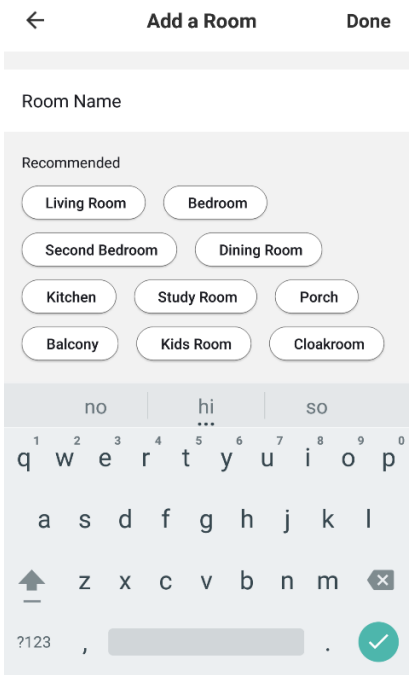
<h3>SETTING YOUR LOCATION</h3> <p>Use your finger to move the orange HOME symbol.</p> <p>When the symbol is in the approximate location of your home, press the confirm button in the top right corner.</p> 	<h3>ADD ANOTHER ROOM</h3> <p>Type in the name of the room, and press Done in the top right corner</p> 
---	---

CONNECTING USING AP MODE

Before initiating the connection, make sure the unit is powered on and that the WiFi light is flashing. Ensure your phone is connected to the WiFi network. (We advise turning mobile data off during setup)

1. Open the app and press “+” to add device

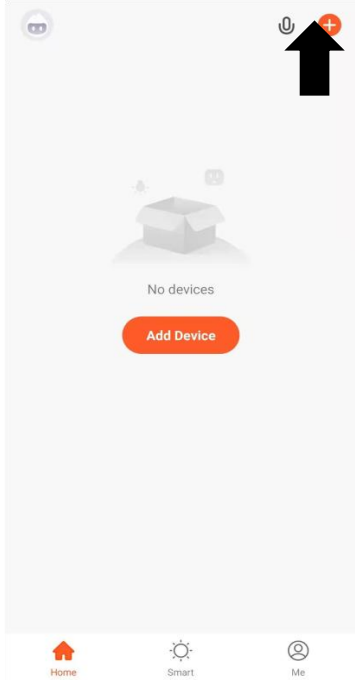

2. Select the type of device as “Air Conditioner (WiFi)” within the Large Home Appliance tab.

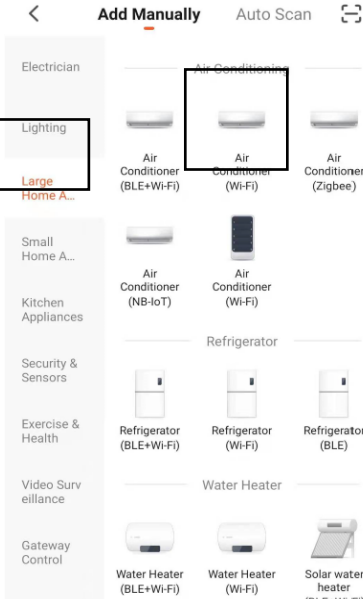

3. Select your network, enter your WiFi password and press Next.

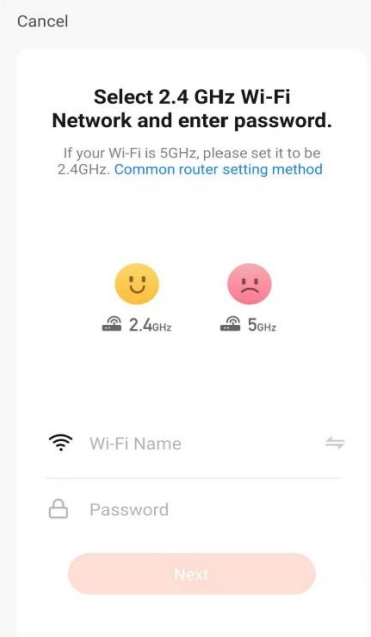

4. Ensure the WiFi light on the air conditioner is slowly flashing (once per three seconds), then select AP Mode in the top right corner before pressing on the orange button at the bottom of the screen to confirm

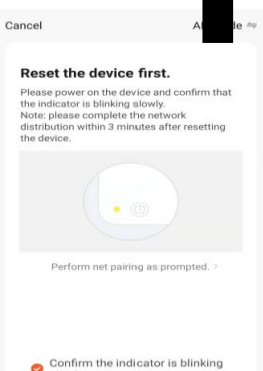

5. Go to network settings in your phone and connect to the “SmartLife xxx” connection. then press on the orange button at the bottom of the screen to confirm

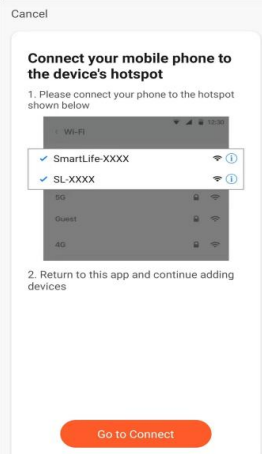

6. Go to network settings in your phone and connect to the “SmartLife xxx” connection. There is no password to enter. Then return back to the app to complete setup.

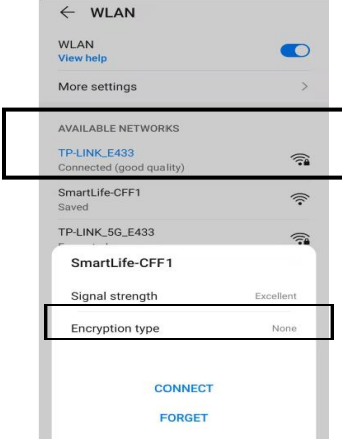

This will then transfer the settings to the air conditioner. Once the connection process has completed, go back to the network settings on your phone to ensure your phone has reconnected to your WiFi router.

CONTROLLING YOUR DEVICE THROUGH THE APP

THE HOME SCREEN

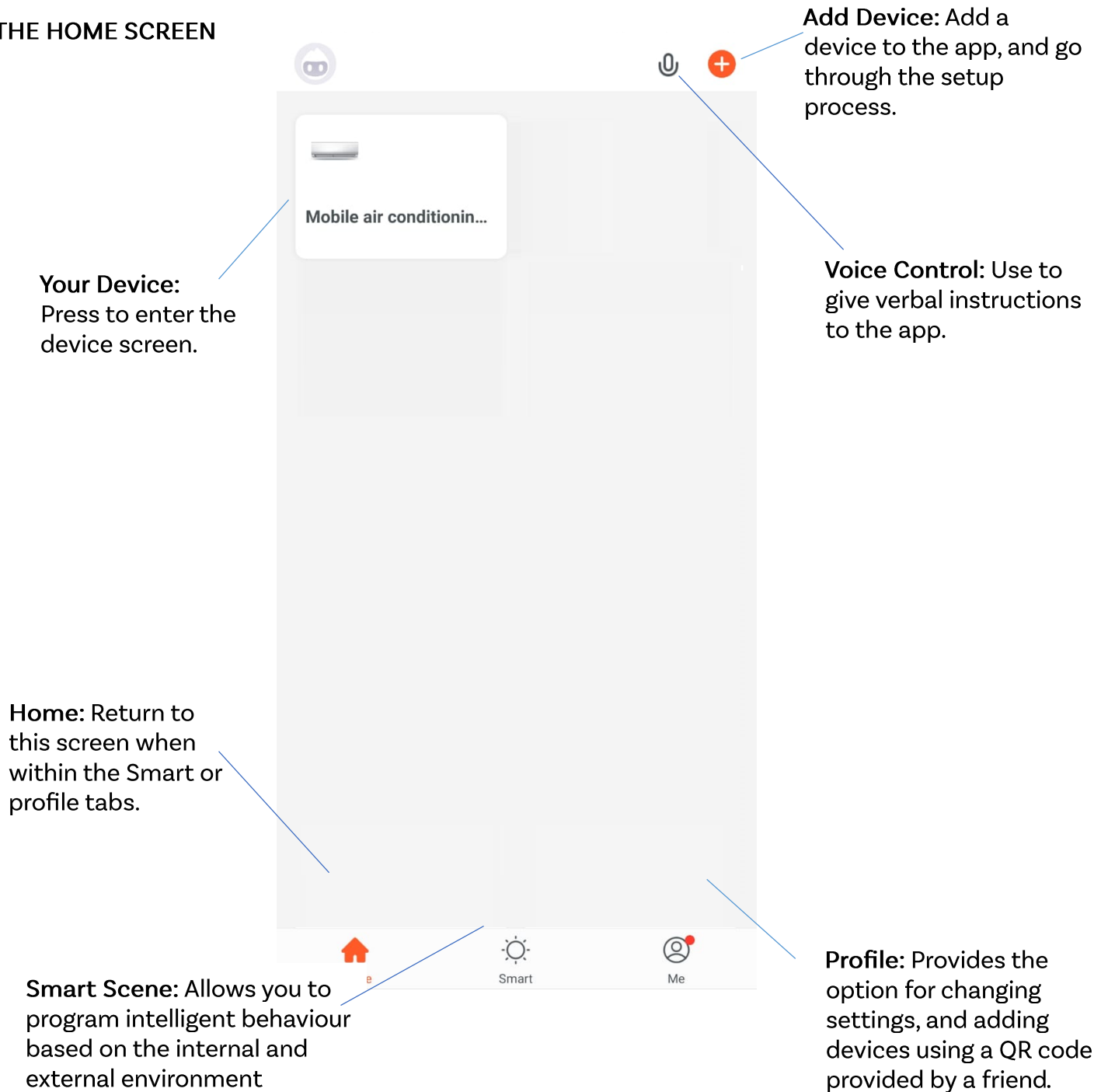

Each device has its own entry on the home screen to allow the user to either quickly turn the unit on or off, or to enter the device screen to make other changes.

DEVICE SCREEN

The device screen is the main control screen for the air conditioner, providing access to the controls for adjusting functions and settings.

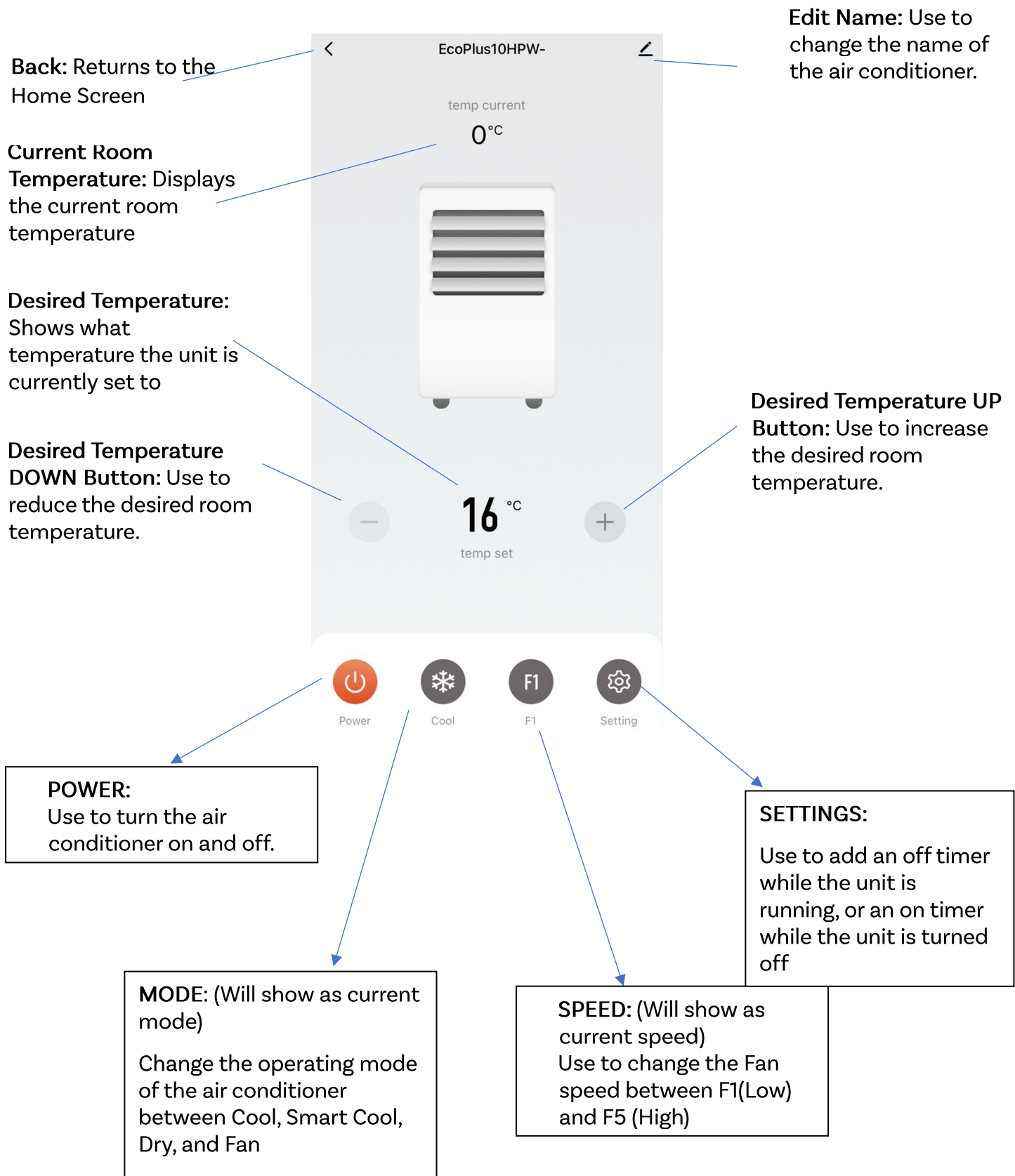

Due to ongoing app development, the layout and available features may change.

SMART SCENES

Smart Scenes is a powerful tool that lets you customise the air conditioner's operation based on both room conditions and external factors. This gives the user the option of specifying much more intelligent actions. These are split into two categories: Scene and Automation.

SCENE

Scene allows for a one-touch button to be added to the Home screen. The button can be used to change multiple settings at once and adjust all settings within the unit. A number of scenes can be set up, allowing the user to switch between preset configurations.

Below is an example of how to set up a scene:

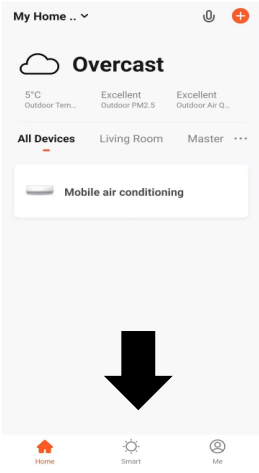
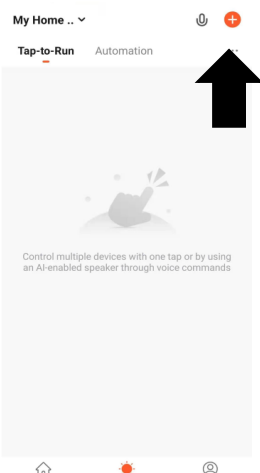
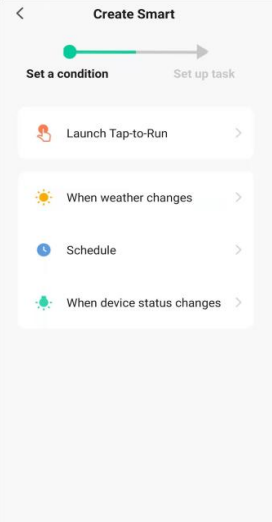
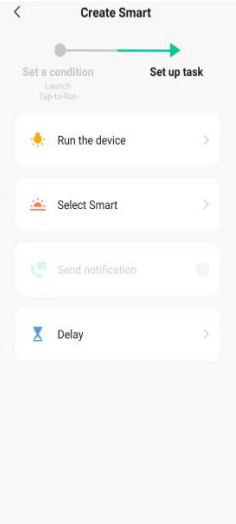
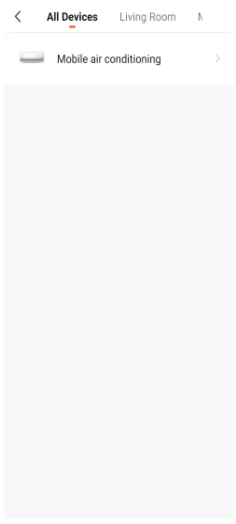
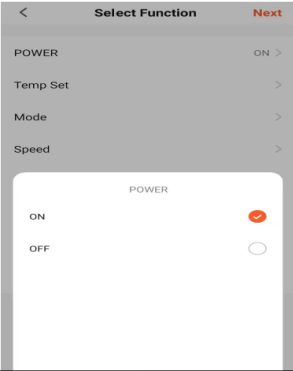
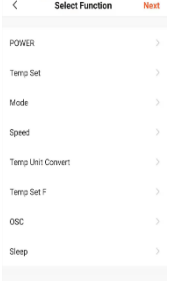
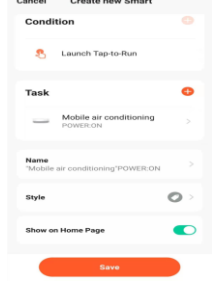
<p>1. Press on the Smart Scene tab at the bottom of the Home screen</p> 	<p>2. Press on the Plus in the top right corner to add a smart scene.</p> 	<p>3. Select the type of Scene to create.</p> 
	<p>4. Select Tap To Run, followed by the device you want to control.</p> 	<p>5. Choose the function, set the value for the function, and then press the back button in the top right corner, to return to the previous screen.</p> 
<p>6. Once all the functions required have been added, press the Next button in the top right corner to finalise and save your new Scene</p> 	<p>7. Once you have named your scene, save it, and the button will be available to activate the scene with one touch within the app.</p> 	

AUTOMATION

Automation allows an automatic action to be set up for the device. Time, indoor temperature and humidity, weather conditions, and other factors can trigger this.

1. Press on the Smart Scene tab at the bottom of the Home screen

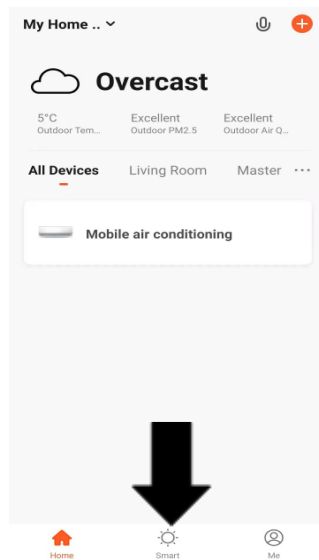

2. Press on the Plus in the top right corner to add a smart scene.

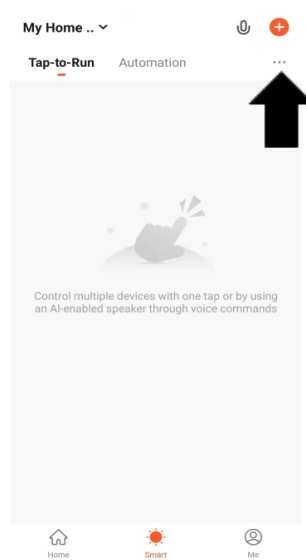

3. Select the type of automation required, such as on schedule for setting up a timed operation.

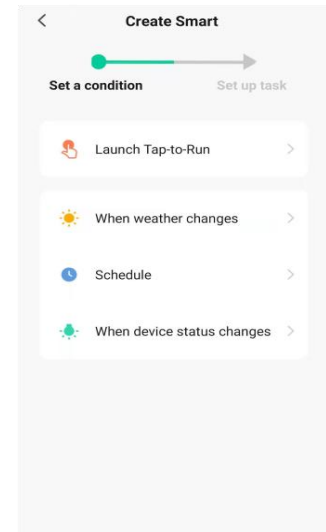

4. Select the condition when the automation should start. A number of triggers can be combined.

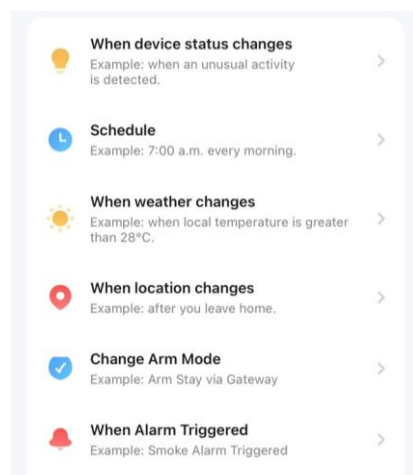

5. Chose the function, set the value for the function, and then press the back button in the top right corner, to return to the previous screen.

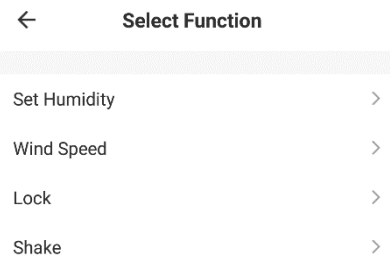

6. Once all the functions required have been added, press the Save button to finalise and save your automated action. The automation can be turned on and off as required.

PROFILE TAB

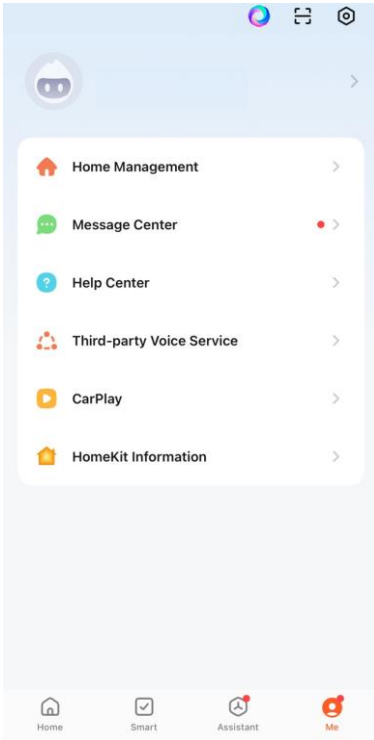

The profile tab gives you the option to edit your details and use the unit's added features.

CHANGING THE NAME OF YOUR DEVICE

On any device screen, further device settings can be accessed by pressing the three dots in the top right-hand corner. The top option in this allows you to change the device name to something relevant to the product's use, such as “Living Room Air Conditioner”. In the menu, you can also set up a pattern lock or change your password.

MESSAGE CENTRE

Shows alerts generated by the App.

THIRD PARTY VOICE SERVICE

This allows the unit to be integrated with your favourite home automation hardware, such as Google Home and the Amazon Echo.

CONNECTION TROUBLESHOOTING

1. If using Bluetooth, ensure it is turned on in your phone settings.
2. Ensure the WIFI password has been entered into the app correctly (Case sensitive)
3. Check that the phone is connected to the WIFI you are connecting the device to.
4. Ensure the network you are connecting to is 2.4Ghz (5Ghz WIFI networks are not supported), and that there is a strong WIFI signal to the item.
5. If your router is dual-band, ensure that the 2.4ghz network has a different network name (SSID). Further advice on changing router settings will be available from your Internet service provider / Router manufacturer.
6. Check the settings on the router. Encryption should be WPA2-PSK, and the authorisation type should be set to AES

CLEANING AND MAINTENANCE

PLEASE SHUT OFF THE UNIT AND UNPLUG FROM THE MAINS BEFORE CLEANING OR PERFORMING ANY MAINTENANCE

CLEAN THE SURFACE

Clean the machine's surface with a wet, soft cloth. Do not use chemicals such as benzene, alcohol, or gasoline, as acidic, corrosive, or alkaline substances may cause damage to the surface and/or the internal workings of the machine.

AIR FILTER CLEANING

If the filter screen is clogged with dust, the air conditioner's effectiveness is reduced. The filter screen should be cleaned every 2 weeks or as often as needed in your environment.

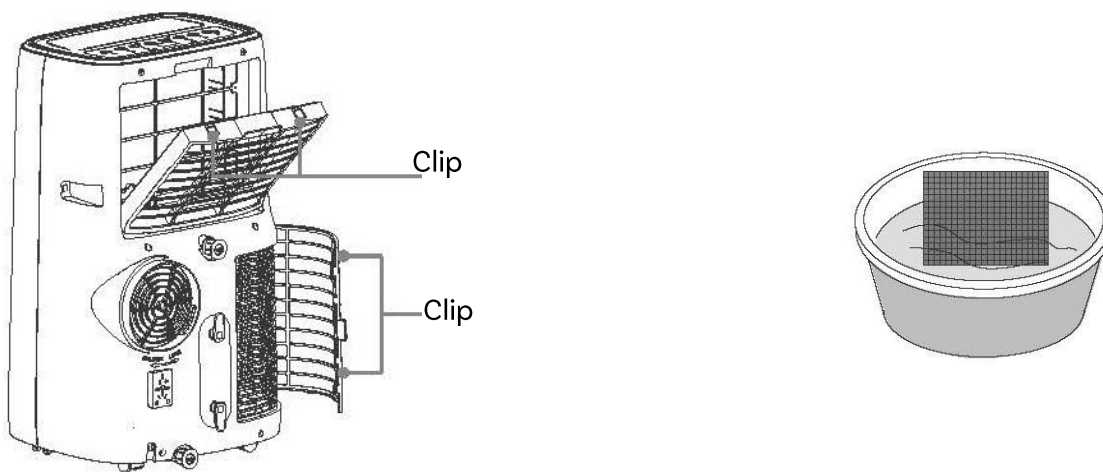

CLEAN THE UPPER FILTER SCREEN FRAME

Remove the top of the evaporator filter screen from the appliance and remove the HEPA filter (if installed). The HEPA filter should be vacuumed and cleaned regularly (around every 2 weeks if used daily). The HEPA filters should be replaced every 6 months, depending on usage.

The evaporator filter screen can be cleaned in warm water with neutral detergent (around 40°C or 104°F). The filter screen must be rinsed clean and thoroughly dried before reinstallation.

CLEAN THE LOWER FILTER SCREEN FRAME

Hold the handle of the lower filter screen and gently pull to unclip the clips and remove the screen. Clean this filter screen in the same way as the upper filter screen.

EMPTYING THE INTERNAL WATER TANK

When the internal water tank is full, the unit will stop working and display FL. There are 2 options for draining the internal water tank:

1) MANUAL DRAINAGE:

The unit should be manually drained after END-OF-SEASON maintenance before any prolonged storage.

Turn off the unit and unplug. Avoid abrupt movements of the model, as this may cause water in the internal tank to spill out.

Place a tray in a drainage area under the lower drain port. Remove the cap and rubber stopper from the drain port - water will drain from the internal tank. Once the tank is empty, place the rubber stopper back in position and secure with the cap.

2) CONTINUOUS DRAINAGE:

Remove the cap and rubber stopper from the upper drain port. Connect a drainage hose (25mm internal diameter) to the drain port. You can plumb this hose into your current plumbing system, lead it outside, use gravity fall, or use an external water pump.

NOTE: This model features self-evaporation, reducing the need to empty the water tank in cooling mode. If the unit is vented correctly, most of the water is reused to cool the condenser coils, and any excess is evaporated. Please do not use continuous drainage if you intend to use the self-evaporating facility.

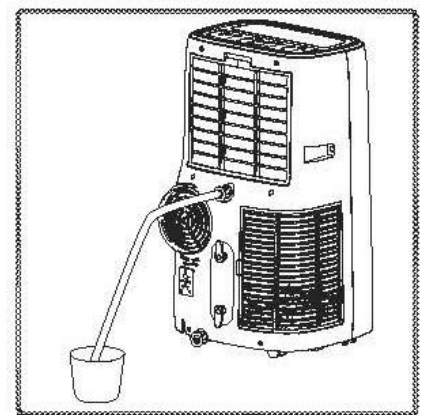
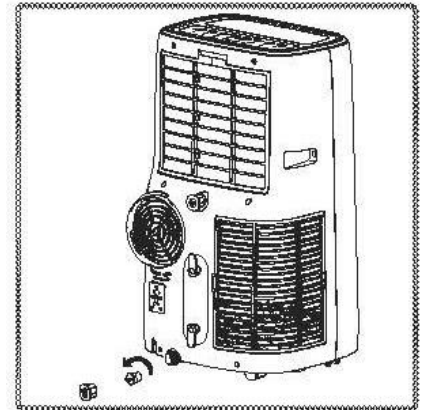

END-OF-SEASON MAINTENANCE

1. Remove the caps and rubber stoppers from the drainage holes and empty the internal tank. You can also drain the water by leaning the unit backwards.
2. Run the unit in fan mode, with a low fan speed, with the rubber stopper still removed and a container under the lower drain port.
3. Keep the unit in this mode for half a day - until the conduit is dry. Doing this helps to keep the inside of the unit dry and prevents mould from developing.
4. Turn off the unit and disconnect the plug.
5. Replace the rubber stopper.
6. Replace the cap.
7. Coil the cable, bind it together, and put it into the cable storage compartment.
8. Separate the vent hose and store it safely.
9. Cover the unit and keep it in a dry place.
10. Take the batteries out of the remote control and store or dispose of them safely.
11. Keep all accessories with the unit ready for next season.

TROUBLESHOOTING

Do not repair or disassemble the air conditioning. Unqualified repair will invalidate the warranty and may lead to failure, causing injuries and property damage. Only use it as directed in this user manual and only perform operations advised here.

Problems	Reasons	Solutions
The air conditioner does not work.	There is no electricity.	Please turn it on after connecting it to a power outlet.
	The display shows "FL".	Discharge the water inside.
	The ambient temperature is too low or too high.	Only use the machine within a temperature range of 7-35 °C
	In cooling mode, the room temperature is lower than the desired temperature.	Change the desired temperature.
	In dry mode, the ambient temperature is low.	The ambient temperature must be above 17 °C
The cooling effect is not good.	There is direct sunlight.	Use curtains to reduce direct sunlight.
	Doors or windows are open; there are a lot of people; or in cooling mode, there are other sources of heat (e.g. fridges)	Close doors and windows; increase air conditioning power
	The filter screen is dirty.	Clean or replace the filter screen.
	The air inlet or outlet is blocked.	Clear obstructions: make sure venting is correct as described in this user manual, and the hose is not bent
Loud Noise	The air conditioning is not placed on a flat surface.	Put the air conditioner on a flat, hard surface (to reduce noise).
The compressor does not work.	Overheat protection starts.	Wait 3 minutes for the temperature to drop, then restart the machine.
The remote control does not work.	The distance between the machine and the remote control is too far.	Bring the remote control close to the air conditioner and ensure it faces the receiver directly.
	The remote control is not aligned with the receiver.	
	Batteries are dead.	Replace batteries.
Others	No refrigerant or there is minimal refrigerant.	Refer to the Service Centre (check leakage, welding, vacuum pump, charge refrigerant according to nameplate)
	Anti-freezing protection	Waiting for defrosting. The function will recover automatically. No user input is needed.
	High-pressure protection.	Once the internal gas pressure drops, it will function normally. No user input is needed.

If problems not listed in the table occur or recommended solutions do not work, please get in touch with the service centre.

1. Has the unit been standing upright for at least 2 hours?
2. Is the unit plugged into the mains?
3. Is the fuse OK?
4. Switch the unit off and wait three minutes to see if the issue is resolved. Restart the unit.
5. Check if the water tank is full.

ERROR CODES

CODE	CAUSE	SOLUTION
E4	Room temperature sensor error	Check to ensure filters are clean, the vent hose is not restricted, and the room temperature is within the operational range.
E2	Coil temperature sensor error	
FL	Water Tank Full	Empty the water tank.
DH	Unit is in dry mode.	No fault, this is the indication of the mode.

TECHNICAL DATA

Model	EcoSilent10W-V2	EcoSilent12W	EcoSilent14W
Cooling capacity:	2930W	3500w	4100w
Rated Input:	1120w	1340w	1570w
Input Current:	5A	5.9A	7A
Fan:	5-speed DC motor		
Airflow:	500m ³ /h		
EER Rate:	2.6 / A		
Refrigerant:	R290/210g	R290/260g	R290/300g
Sound Power Level:	62dB(A)		
Sound Pressure Level	38-51dB(A)		
Thermostat:	16-32°C		
Maximum Allowable Pressure of suction/ exhaust side:	1.0/3.5Mpa		
Maximum Allowable Pressure	3.5MPa		
Power Supply:	AC 230V/50 Hz		
Net Weight:	27.5 Kg	28.1 Kg	28.9Kg
Dimension(L*D*H):	395*358*718 mm		
<p>The unit must be vented outside when in air-cooling mode. For the purposes of EU regulation EN12102, this is a local air conditioner that produces less than 65dB(A) sound energy.</p> <div style="text-align: center;">  <p>R 290</p> </div>			

PRODUCT FICHE

Description	Symbol	Value			Unit
		Ecosilent10W-V2	Ecosilent12W	Ecosilent14W	
Rated capacity for cooling	$P_{\text{rated for cooling}}$	2.93	3.5	4.1	kW
Rated power input for cooling	P_{EER}	1.12	1.34	1.57	kW
Rated Energy efficiency ratio	EER_d	2.61			-
Power consumption in thermostat-off mode	P_{TO}	75.9	78.4	79.7	W
Power consumption in standby mode	P_{SB}	2.0			W
Electricity consumption of single/double duct appliances	SD: Q_{SD}	0.88	1.23	1.26	SD: kWh/h
Sound power level	L_{WA}	62			dB(A)
Global Warming Potential	GWP	3			kgCO ₂ eq.

PSTI STATEMENT OF COMPLIANCE

Description: Air Conditioner

Model Number: EcoSilent10W-V2, EcoSilent12W, EcoSilent14W

Manufacturer: electriQ, 2A Trident Business Park, Leeds Road, Huddersfield, HD2 1UA

PSTI Contact: TiSecurity@buyitdirect.co.uk

We have prepared this statement of compliance and can confirm that this product is compliant with the deemed compliance conditions in Schedule 2 of The Product Security and Telecommunications Infrastructure (Security Requirements for Relevant Connectable Products) Regulations 2023.

Duration of security updates: 31/12/2030. This date is correct at the time of printing, but we may be extended. Please visit www.electriQ.co.uk for the latest information and details of our PSTI compliance.

Richard Leach

Compliance and Quality Manager, Buy It Direct, Huddersfield



19th December 2025

EU DECLARATION OF CONFORMITY

Hereby, electriQ declares that these air conditioners are in compliance with Directive 2014/53/EU. The full text of the EU declaration of conformity is available at the following internet addresses:

<https://www.electriq.co.uk/files/DOC/EU/EcoSilent10W-V2.pdf>

<https://www.electriq.co.uk/files/DOC/EU/EcoSilent12W.pdf>

<https://www.electriq.co.uk/files/DOC/EU/EcoSilent14W.pdf>

UK DECLARATION OF CONFORMITY

Hereby, electriQ declares that these air conditioners are in compliance with Radio Equipment Regulations 2017. The full text of the UK declaration of conformity is available at the following internet addresses:

<https://www.electriq.co.uk/files/DOC/UK/EcoSilent10W-V2.pdf>

<https://www.electriq.co.uk/files/DOC/UK/EcoSilent12W.pdf>

<https://www.electriq.co.uk/files/DOC/UK/EcoSilent14W.pdf>

electriQ UK SUPPORT

www.electriQ.co.uk/support

Please review the troubleshooting section for your convenience before calling the service line.

Call the number below if the unit fails to operate or complete the online form.

0330 390 3061

Office hours: 9 AM - 5 PM, Monday to Friday

www.electriQ.co.uk

Unit 2A, Trident Business Park,
Neptune Way, Leeds Road, Huddersfield, HD2 1UA.



Disposal: Do not dispose this product as unsorted municipal waste. Collection of such waste must be handled separately, as it requires special treatment. Recycling facilities are now available to all customers, where you can deposit your old electrical products. Customers will be able to take any old electrical equipment to participating civic amenity sites run by their local councils. Please remember that this equipment will be further handled during the recycling process, so please be considerate when depositing your equipment. Please get in touch with the local council for details of your local household waste recycling centres.